

1

العملية السييفية لعظمة آدم  
العمالة

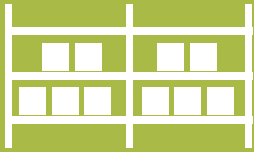

المطبخ  
فتحة النجف



# SMART KITCHEN

## INFRASTRUCTURE GUIDE

PART I - SPATIAL PLANNING AND REQUIREMENTS



## الداعي الاجل الحبي المقدس سيدنا محمد برهان الدين <sup>رض</sup> فرماوے چھے:

اهنا کرتا زيادة اهم **KITCHEN** نو امر چھے ، يهنا اكثر صفائي ني كمي هوئي چھے ، **KITCHEN HYGIENE** نو خاص خيال مراكهوو جوئيے ، اهو و جن بناوے كرجر صحت واسطے فائده مند هوئي . . .

ملوك ال محمد هميشه دعاء كرون چهون ، يه دعاء مامر ب چھے ، كوئي احسان نتهي ، سون دعاء كر خدا تعالى هرايك مؤمن مؤمنه انے پيارا فرزندونے پوتاني حفاظة ، كلاية انے مراكهوو ليجر اكهے ، سگلانے صحت مند انے تندرست مراكهے ، عمرنا آخر لگ عافية نا فاخر لباس ما باقي مراكهے ،

مؤمنين ني جمعة! بعض ذكر كيدي يه مثل عمل كرسو تو ميں خوش تهئيس انے داعي نادل خوش كرو انو ثواب تمنے ملسے !

## الداعي الاجل سيدنا عالي قدر مفضل سيف الدين <sup>طع</sup> فرماوے چھے:

مؤمنين! جن جمار و ماگنهو ثواب چھے ، اچے تمام بلاد ايمانية ما فيض الموائد البرهانية جاري چھے ، مؤمنين بركة لئي مرهيا چھے ، يه واسطے خاص اهتمام ني ضرورة چھے تاكر مؤمنين **HYGIENIC** جن جمے انے خوش تهائي ، **KITCHEN** واسطے بهي خاص اهتمام كروو جوئيے ،

(المجلس التاسع - ۱۴۳۶ھ)



## PREAMBLE

This guide – prepared by Faiz ul Mawaid il Burhaniyah Office, Badli Mahal, Mumbai – is intended to be a practical help in the design of FMB kitchens, following the standards of a smart kitchen. This manual is made in conjunction with architects, kitchen design specialists, services consultants, specialists in the hospitality industry and chefs.

**The aim of this guide is to provide with recommendations for implementing efficient, safe and best practice for FMB Kitchens (including kitchen managers, designers and FMB kitchen users). Within each section are recommendations, processes and precautions that contribute to the efficient running of an FMB Kitchen, whether it is small, medium or large.**

This guide should be used when designing new kitchens or renovating existing kitchens. It deals specifically with the layout of equipment and departments and provides guidance on the functional relationships. Additionally, it contains the requirements for finishes, services and building requirements. Compliance with the guide will ensure that facilities will meet FMB requirements.

**This guide is divided into three parts**

- I. Spatial planning and requirements
- II. Services and specifications
- III. Layouts and annexes

**Part I explains kitchen zones and their functional relations to each other. It also identifies layout considerations for each zone along with equipments and fittings required.**

## THE LAW IN YOUR KITCHEN

The design of an FMB Kitchen facility is required to meet all local statutory legislation prevalent in your city/ country.

These guidelines are meant to support the existing codes of practice and standards set by local regulating authorities.

In India the most important building and food hygiene regulations are:

- National Building Code of India, 2005
- Food Safety and Standards Act, 2006
- Food Safety and Standards Authority of India, 2011

Keeping in consideration the fact that all FMB Kitchens do not need elaborate facilities, the mawze should choose the requirements according to size of their operations and budget. Present population and foreseeable future requirements should be also taken into consideration. This guide segregates the requirements under three heads for each area:

- **MANDATORY** – Basics (essential and must)
- **RECOMMENDED** – Value addition
- **OPTIONAL** - Convenience

**Note:** All dimensions are in millimeters unless specified otherwise.

**Whenever niyaz thaal are served from the same kitchen; thaal serving and related services must be taken into consideration.**

# CONTENTS

<b>1. INTRODUCTION</b>	<b>1</b>
<b>2. MASTER PLANNING AND DESIGN</b>	<b>2</b>
<b>3. WORK FLOW PATTERNS</b>	<b>3</b>
<b>4. SPATIAL PLANNING</b>	<b>4</b>
<b>5. SPATIAL REQUIREMENTS</b>	<b>6</b>
A. Kitchen office	6
B. Staff amenities	7
C. Goods receiving area	9
D. Storage	11
E. Air lock lobby	14
F. Preparation areas	15
1. Vegetable preparation	15
2. Meat preparation	16
G. Cooking	18
H. Thaali filling and distribution	19
I. Zabihat and Butchery	20
J. Roti Making	23
K. Pot wash	23
<b>6. SIGNAGE</b>	<b>25</b>



# 1. INTRODUCTION

## Kitchen design & food safety

A principal objective of kitchen planning is ergonomic efficiency, making optimum use of workers' activity within the work place. This can be achieved by making work flow as efficient as possible.

The design and construction of all kitchens should:

- Be convenient to use, easy to clean/disinfect maintain and repair.
- Prevent condensation and formation of mould/fungus.
- Provide appropriate temperature conditions for the processing and storage of products.
- Provide protection of cross contamination between and during operations – by food stuffs, equipment, materials, water, air supply and staff or by external sources, including pests.

## Cross Contamination & Hazards

The planning shall focus to avoid and control cross contamination by separation of activities (Refer Exhibit 04, pg 05). This can be achieved by:

- Efficient planning and design (external and internal)
- Construction Methods
- Specifications
- Services and Management

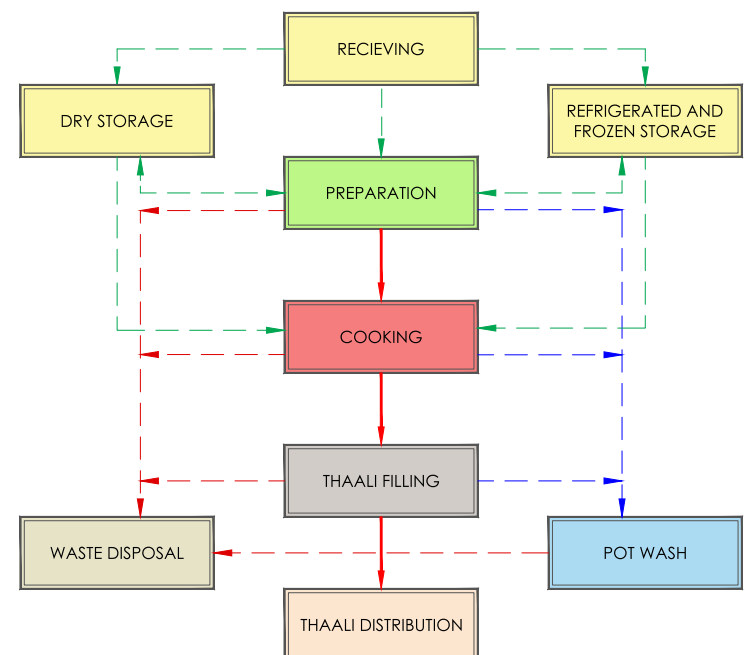

### LEGEND

	FOOD		UTENSILS
	WASTE		GOODS

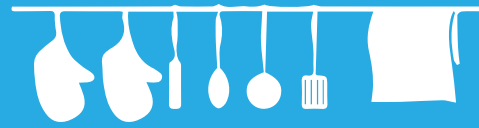

## 2. MASTER PLANNING & DESIGN

- The kitchen and its ancillary areas should be located on the ground floor of a building with direct level access for deliveries, distribution and the removal of waste. If proposed area is above or below ground level, efficient work flow must be maintained.
- The kitchen should have separate entry and exit for man, material and waste.
- The design shall segregate the clean (cooking area, preparation and roti making area) and non clean areas (pot wash, thaali distribution, stores and staff facilities).
- Storage of edible foodstuffs and cleaning material must be separate.
- The layout, planning and design of the kitchen should allow easy access to all areas and surfaces for cleaning, particularly cooking and preparation areas to avoid awkward corners that aid the accumulation of dirt.
- The provision of adequate and appropriate working conditions with regard to temperature, air purity and lighting must be considered.
- Low height internal walls (1.8mts) shall be constructed to segregate spaces like preparation areas, cooking areas, cold/refrigerated storage and pot wash; this will enable good cross ventilation and allow visual access.
- Sufficient chilling and frozen storage equipment should be provided.
- An entrance should be designed with vehicular access for easy movement of thaali distributors upto the thaali dispatch area.



### 3. WORKFLOW PATTERNS

A typical workflow pattern is shown below. The linear flow principle leads to a logical design and the efficient movement of work.

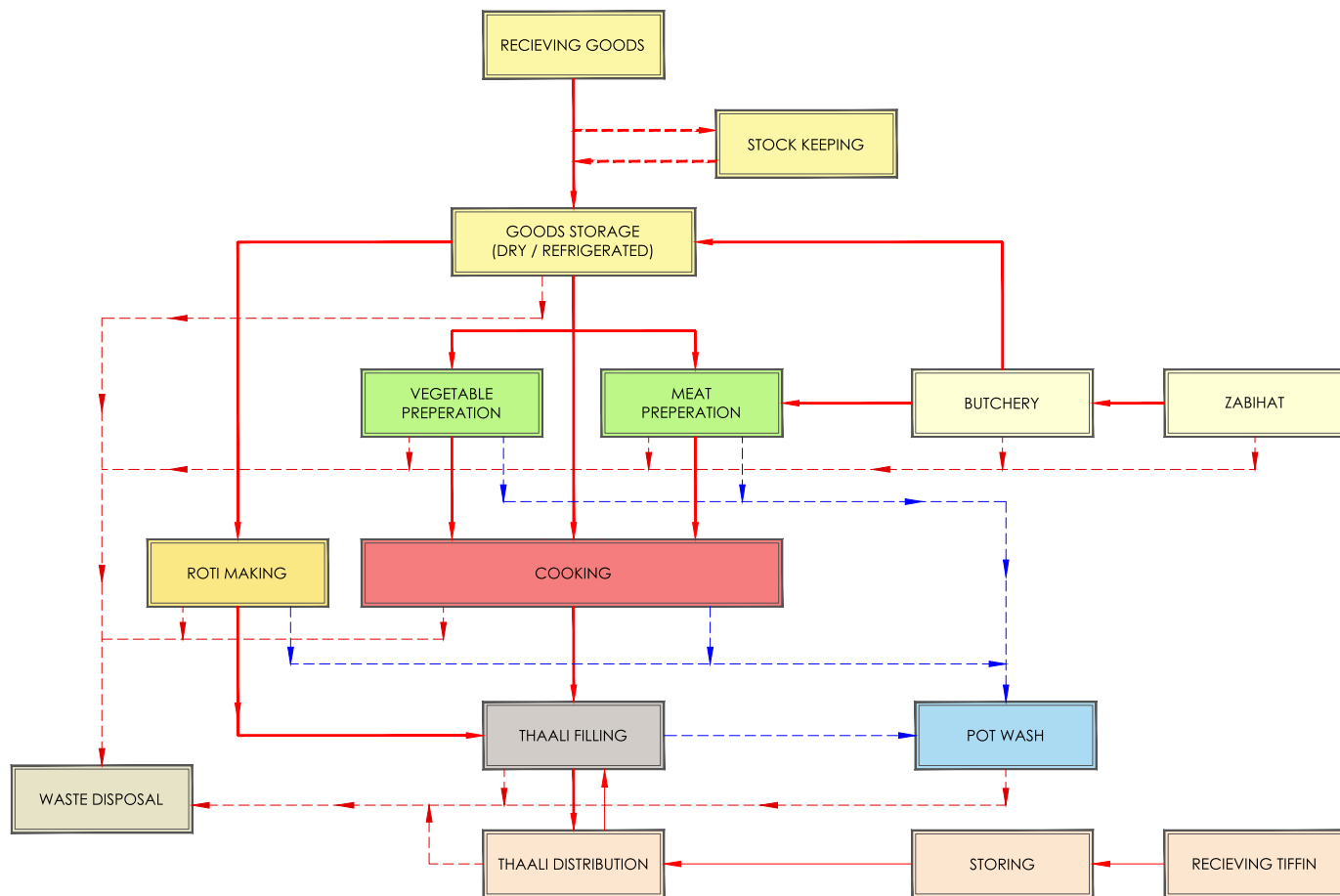

- LEGEND**
- FOOD
  - WASTE
  - UNTENSILS

Exhibit 02: WORK FLOW DIAGRAM

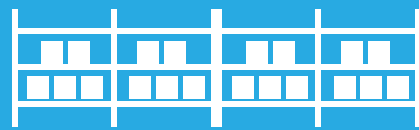

## 4. SPATIAL PLANNING

To maintain effective movement through spaces, the area required is 2-3 sq.ft. per person to be catered.

### Zoning Considerations

The movement of food through the facility should follow a logical sequence beginning with receiving and ending with thali distribution. For example:

- Movement of employees from one area of the facility to another
- Flow of materials from the loading dock to storage areas
- Flow of raw foods through the main traffic aisles of the kitchen to the preparation area, subsequently to cooking areas.
- Flow of pots, pans, and other utensils through the pot wash area to clean utensil storage.
- Flow of distributors at the thali distribution area to the vehicle drop-off area.

**A well planned kitchen should be divided into zones as shown in the diagram.**

#### LEGEND

INDEPENDENT	
INDIRECT	
PROXIMITY	
DIRECT	

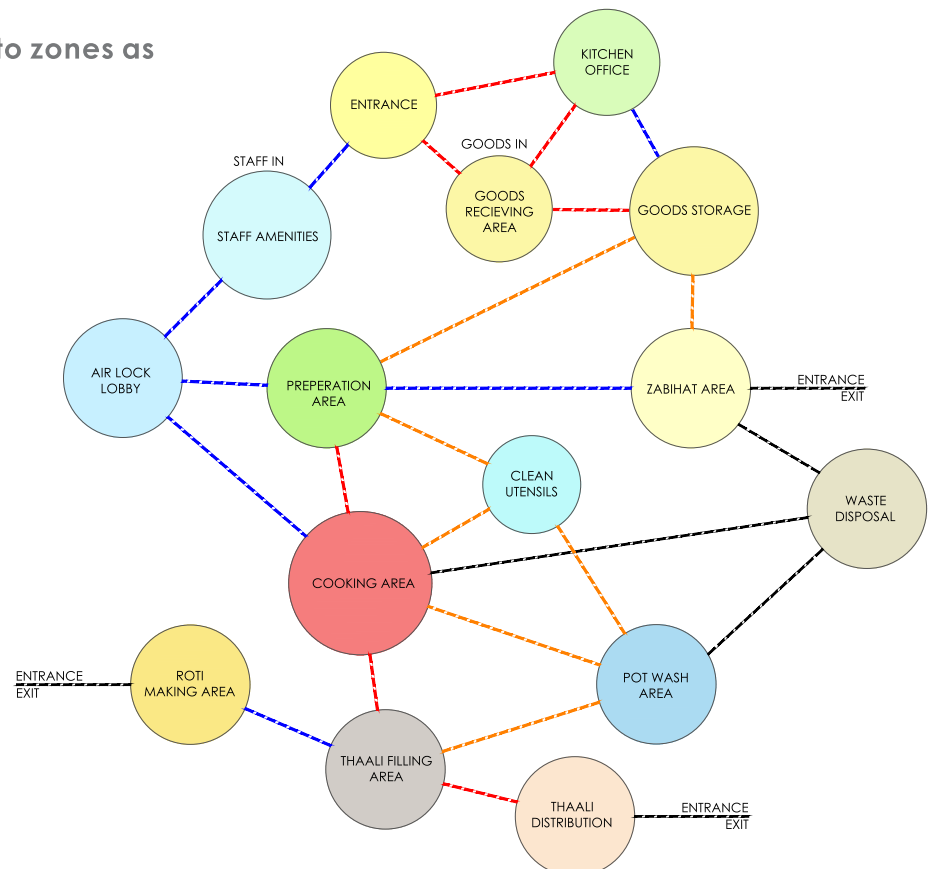
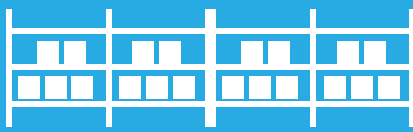

Exhibit 03:

**ZONING & FUNCTIONAL RELATIONSHIP DIAGRAM**



## Layout Considerations

- Travel distances should be kept short and there should be minimal crossover of circulation paths.
- Clear sight lines should be maintained as much as possible.
- Provide adequate space for goods receiving and storage, food preparation and dispatch and storage of utensils.

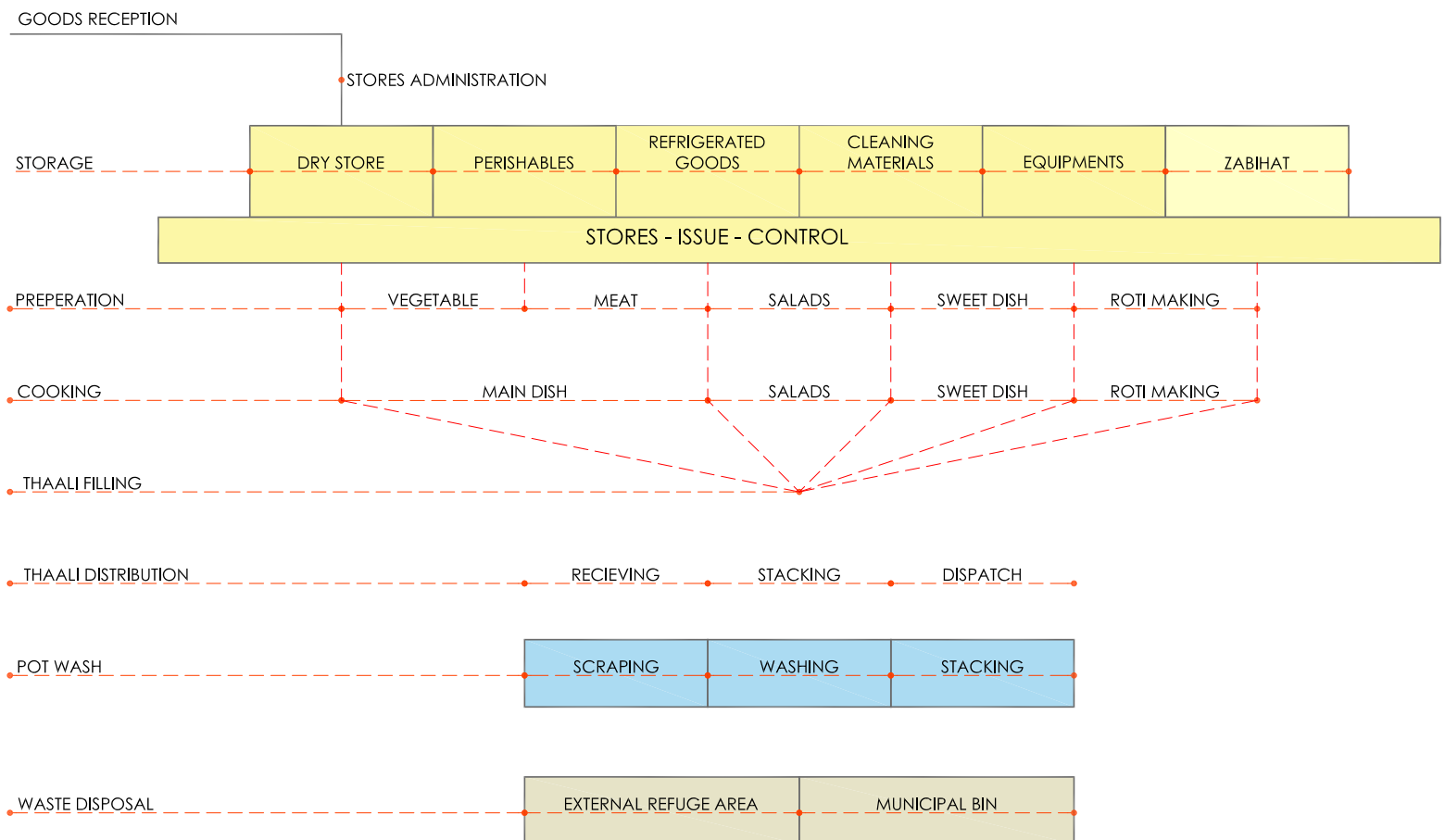

Exhibit 04: **KITCHEN ACTIVITIES**



## 5. SPATIAL REQUIREMENTS

The key spaces of a FMB kitchen are:

- A. Kitchen office
- B. Staff amenities
- C. Goods delivery and receiving
- D. Goods Storage
- E. Air lock lobby
- F. Preparation areas
  - 1- Vegetable preparation
  - 2- Meat preparation
- G. Cooking
- H. Thaali filling and distribution
- I. Roti Making
- J. Zabihat and Butchery
- K. Pot wash

### A. Kitchen Office

The kitchen office is the focal point for the administration and control of the facility.

### Layout Considerations

- The office should be located in a way that provides monitoring of all the activities. Vision panels should be provided to allow maximum view of the kitchen area.

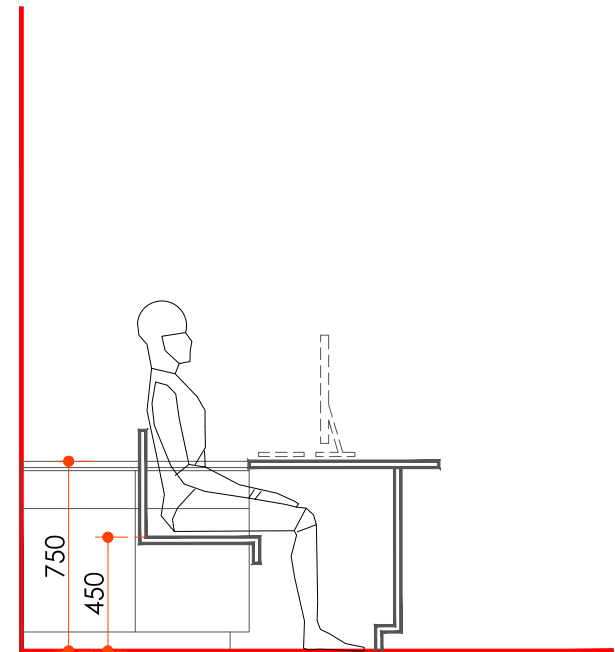
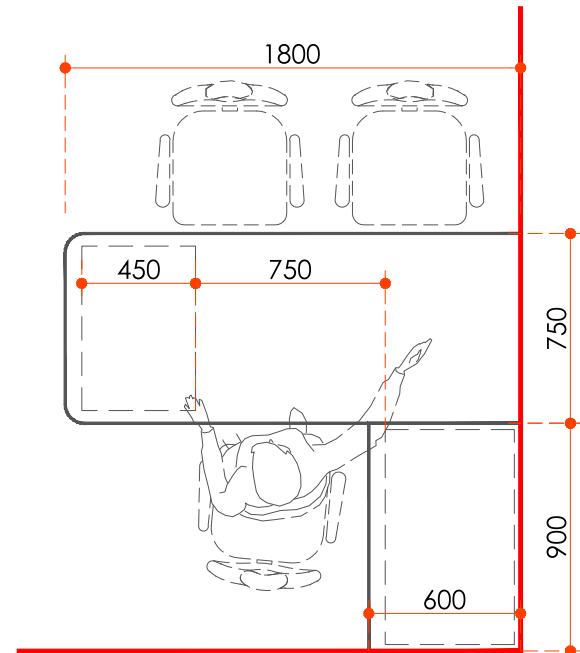

Exhibit 05: TYPICAL OFFICE DESK



- Adequate natural light and ventilation shall be provided.
- Should have electrical, LAN and telephone connections
- Monitoring system like CCTV etc.

## Equipments & Fittings

The kitchen office may require the following equipment:

- Desk and chair (Refer Exhibit 05, pg 6)
- Computer and printer
- Lockable key cupboard and filing cabinet
- First aid box
- Notice board

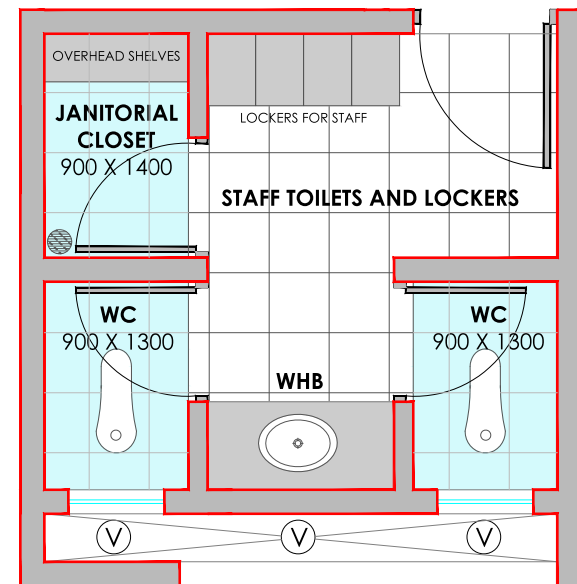

Exhibit 06: **TYPICAL STAFF AMENITIES**

## B. Staff Amenities

Staff amenities in a kitchen are (Refer Exhibit 06):

- i. Changing area and toilets
- ii. Janitorial/cleaners closet

### i. Changing Area and Toilets

Changing facilities for staff are required to change from outdoor clothing to protective work wear.

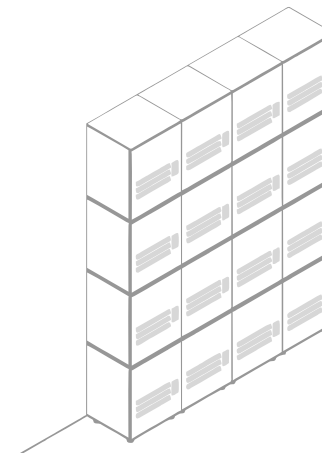

Exhibit 07: **TYPICAL LOCKERS**



## Layout Considerations

Staff facilities should be located such that it does not interfere with any of the kitchen activities.

- Toilets should be located away from the main kitchen areas.
- Changing/locker area must be planned to provide indirect access to toilets from other areas.
- Toilets must be adequately ventilated.
- Wash basins should be provided outside WC's.

## Equipments & Fittings

- Dust bins and soap dispensers in toilets
- First aid kit
- Door closers
- Lockers for clothing and personal belongings

### ii. Janitorial/Cleaners Closet

The cleaners closet is used for the storage of the day-to-day cleaning materials and equipment such as brooms, buckets, mops, floor cleaning machine, power washer, etc. **(Refer Exhibit 08)**

This is essential to discourage use of pot wash and other sinks for cleaning activities.

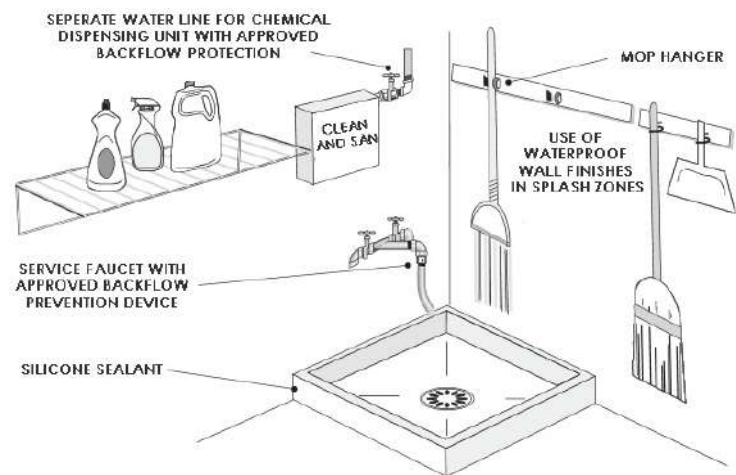

Exhibit 08: **JANITORIAL CLOSET**



## Layout Considerations

- Should be located away from food preparation areas. Can be clubbed in toilet area.
- A water tap and floor trap for the filling and emptying of buckets, washing and rinsing of mops, etc must be provided.
- Necessary arrangements to be made for hanging mops and brushes for drying.
- Ceramic tile cladding on wall to be provided for easy cleaning and maintenance.

## Equipments & Fittings

- Janitorial unit - combined wash hand basin and bucket sink.
- Storage rack of stainless steel
- Equipment rack
- Floor cleaning machine
- Wet/Dry vacuum machine

## C. Goods Receiving Area

The activities in this area involves

- Receiving of goods
- Handling
- Checking
- Recording



## Layout Considerations

- Plan the unloading platform, stores and preparation areas in proximity and same level to limit the number and distance of material transfers. In case of different floor levels, locate storerooms adjacent to elevators or stairways.
- Area to be completely separate from waste disposal and storage areas, grease traps and manholes.
- Design unloading platform to have vehicular access, waste bins, materials handling equipment like trolleys, weighing scales and sorting table to adapt to work process.
- Provide durable, slip-resistant, leveled floor surfaces that are easy to clean and maintain. Avoid thresholds and uneven drains.
- Provide steps with rails. **(Refer Exhibit 10, pg 11)**
- Provide ramp to facilitate use of hand carts or trolleys. Ramp should have maximum slope of 1:12. **(Refer Exhibit 10, pg 11)**
- Provide canopy extending beyond loading-unloading platform for weather protection. Canopy height must accommodate vehicles servicing the facility. **(Refer Exhibit 9)**
- Install edge guards and dock bumpers on unloading platform.

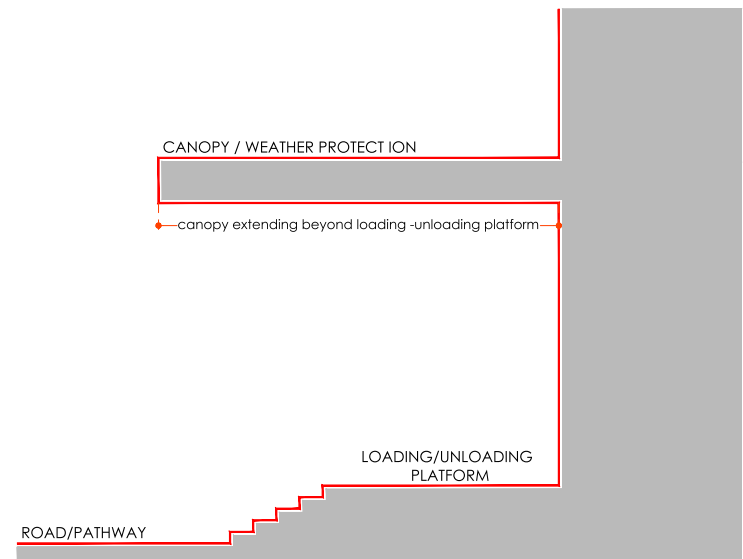

Exhibit 09: **UNLOADING PLATFORM**

- Provide hose connections and concealed drainage to sanitation system to clean floor and equipments like trash containers, carts and floor mats etc.
- Match unloading platform heights with the type of truck servicing the facility.

## Equipment & Fittings

- Trolleys
- Weighing scales
- Sorting table
- Waste bins

## D. Goods Storage

The amount and the type of storage will depend on:

- The size and volume of the kitchen
- Delivery frequency of goods
- The duration of storage

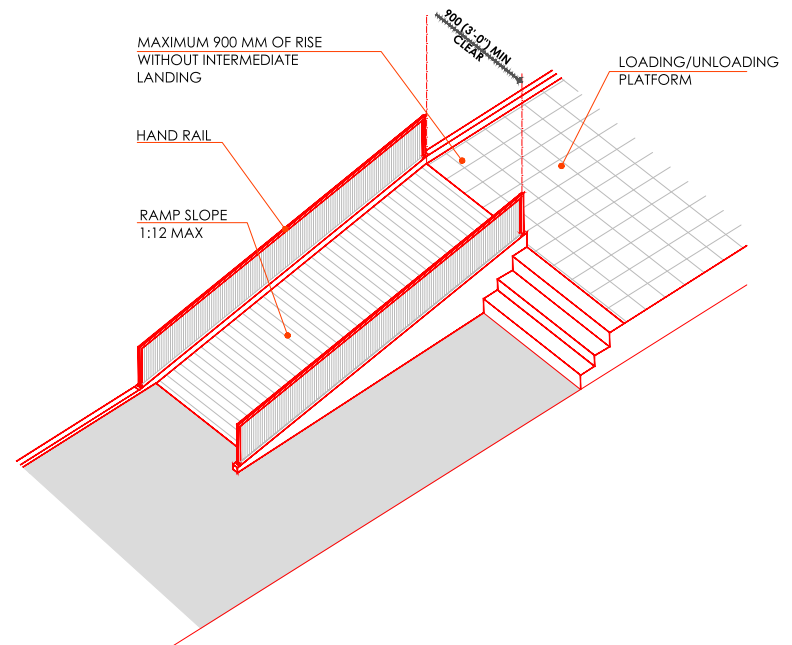
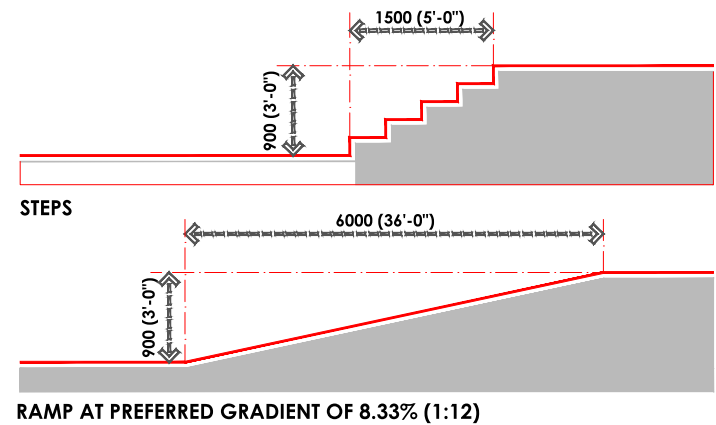

Exhibit 10: ENTRANCE STEPS AND RAMP



## Storage Requirements

Types of storages:

- Dry goods
- Refrigerated goods
  1. Fresh vegetables
  2. Dairy products
  3. Meats, poultry and fish
- Onion and potato storage
- Utensils and equipments
- Tiffins
- Cleaning equipment and chemicals

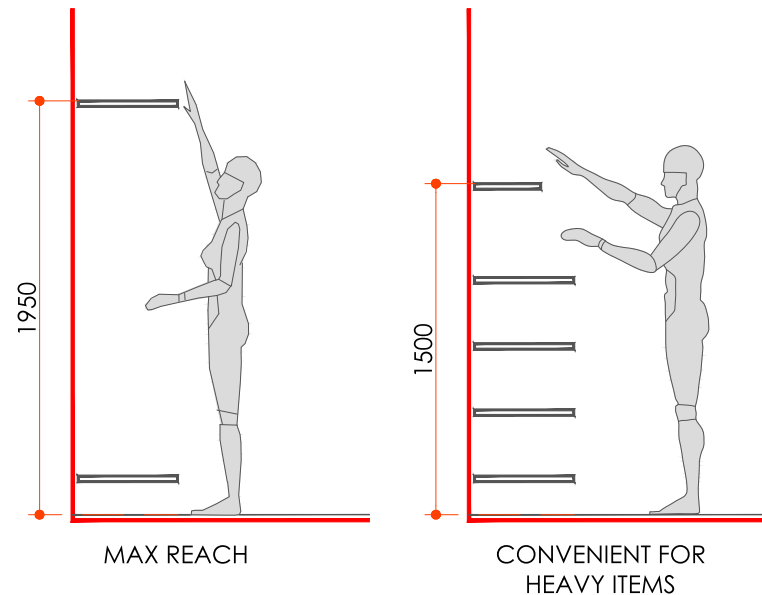

Exhibit 11: **SHELVING HEIGHTS**

## D-1. Dry Store

### Layout Considerations

- Storage area should have easy access to the kitchen office, the kitchen and the unloading area.
- Dry store should be in cool area and not adjoining boiler or plant room where heat transfer through the walls and piping is likely.
- Access to the store and the corridors shall be wide for easy movement of goods and trolleys. No items should be stored in corridors or pathway.
- The area must be well ventilated and provide sufficient air changes.
- Flooring should be easy to clean and non slippery. Floors should be continuous and level with no ramps, thresholds, lips or uneven drains.
- Walls should have ceramic tile cladding or painted with washable paint for ease of cleaning.
- Ceiling should be closed and painted (concrete painted or moisture resistant drop ceiling surface covered with easy to clean material).



- Windows should be covered with rust proof metal nets to prevent insects and pests from entering the store.
- The temperature shall be below 25°C and humidity should not exceed 65%.
- A desk and filing cabinet can be provided for store keeper.
- Use lockable double swing doors with vision panels to avoid collisions and improve sight lines.
- Consideration should be given for spare utensil and equipments (not frequently used) while deciding the size of store. Providing this space in store will allow a hindrance free working area in the main kitchen.

## Equipment & Fittings

- Rust proof cages for potatoes and onions
- Racks
  1. Sturdy of rust proof metal
  2. On lockable castors or wheels for ease of redesign and cleaning
  3. Min 30cm off floors and 5cm off walls
  4. Height adjustable and labeled shelves
- Trolleys
- Desk and chair
- Computer and printer
- Lockable filing cabinet
- Notice board

## D-2. Cold Store

### Layout Considerations

- Refrigerators should be set to less than 5°C and freezers should be less than -18°C.
- Walk in fridges and freezers



## D-3. Hazardous Substances

- Hazardous substances like cleaning agents and pest control chemicals must be appropriately labeled, color coded and stored in janitorial / cleaner's room in a lockable closet or space. (Refer Exhibit 08, pg 8)

## E. Airlock Lobby

- It is an area or room between a pair of doors that separates the kitchen area from other facility or other spaces.
- The function of airlock lobby is to cut off the non-hygienic areas (ancillary areas like office, store, staff facilities) from hygienic areas (preparation and cooking areas).
- The air lock lobby permits the movement of staff without affecting the inward flow of air into the kitchen area, since at least one door is kept closed at all times.
- Person should change into kitchen foot wear before entering the kitchen through the airlock lobby.
- The air lock lobby must not be used for storing equipments this limits access to visitors, vendors and staff up to the kitchen office and staff facilities only.

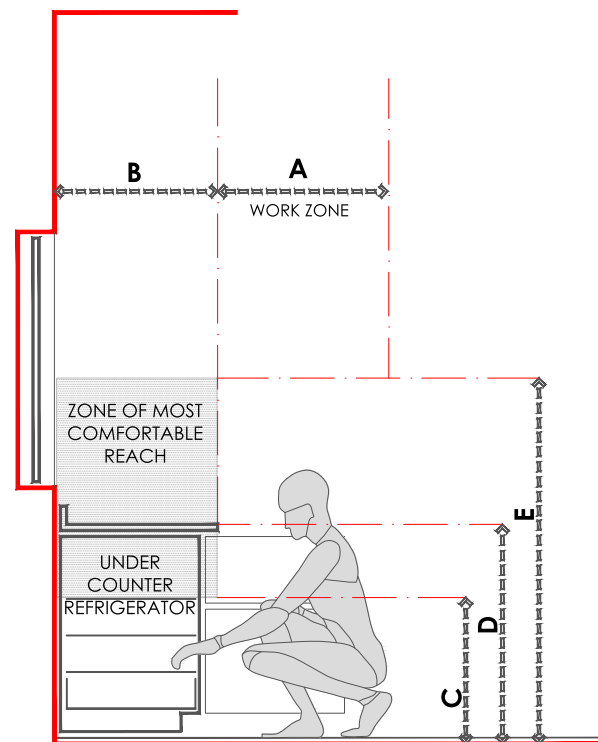

	INCHES	MM
A	36	900
B	24 - 26	600 - 650
C	25.5	645
D	35 - 36	875 - 900
E	59	1475

Exhibit 12: **UNDER COUNTER REFRIGERATOR**



## Equipment & Fittings

- Shoe rack
- Cap and glove dispenser
- Hand sanitizers

## F. Preparation Areas

The preparation areas should be separate from cooking areas. They have functional relationship with the goods receiving area, stores and the main kitchen.

Equipment should be laid out to make best use of the space available and provide a linear workflow from the preparation areas through to the kitchen. **(Refer Exhibit 14, pg 16)**

Preparation area is divided to the following zones:

- Vegetable preparation area
- Meat preparation area

In larger sized kitchen, separate vegetable and meat wash areas should be provided.

### F-1. Vegetable Preparation Area

- Fresh water source from the municipal supply /treated water (RO) and hot water should be provided for washing vegetables and other ingredients.
- All equipment must be easy to move for cleaning.
- Surfaces in contact with food must be non-absorbent to grease, food particle or water.
- Provide sufficient dry and under counter refrigerated storage. **(Refer Exhibit 12, pg 14)**

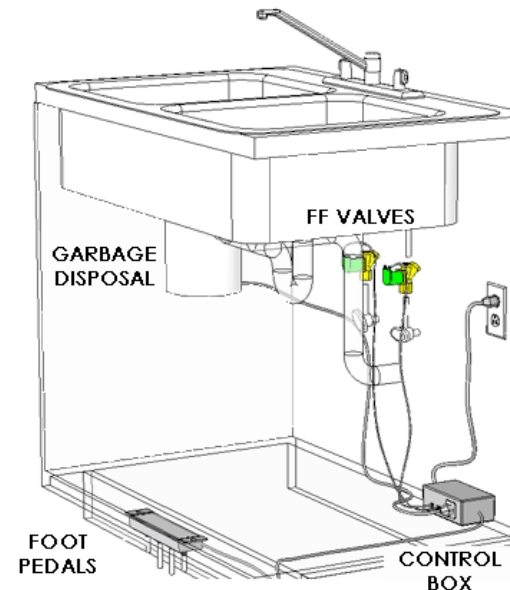
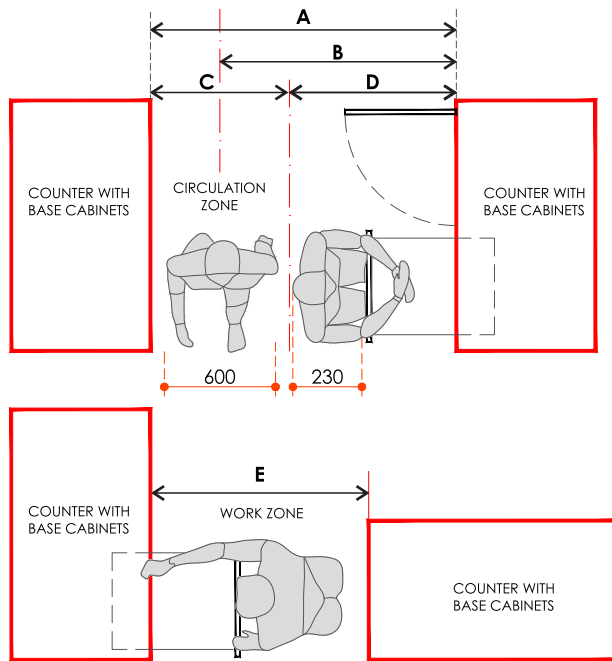

Exhibit 13: **FOOT OPERATED KITCHEN SINK**



## F-2. Meat Preparation Area

The meat preparation provides preparation facilities for meat, poultry and fish prior to cooking. The meat preparation area has a functional relationship with the main kitchen, storage and zabihat area.



	INCHES	MM
A	60 - 66	1500 - 1650
B	48 MIN.	1200 MIN.
C	24 - 30	600 - 750
D	36	900
E	48	1200 MIN.
F	12 - 13	300 - 325
G	76 MAX.	1900 MAX.
H	72 MAX.	1800 MAX.
I	59	1475
J	25.5	645
K	24 - 26	600 - 650
L	15 MIN.	375 MIN.
M	18	450
N	35 - 36	875 - 900
O	69 MAX.	1725 MAX.

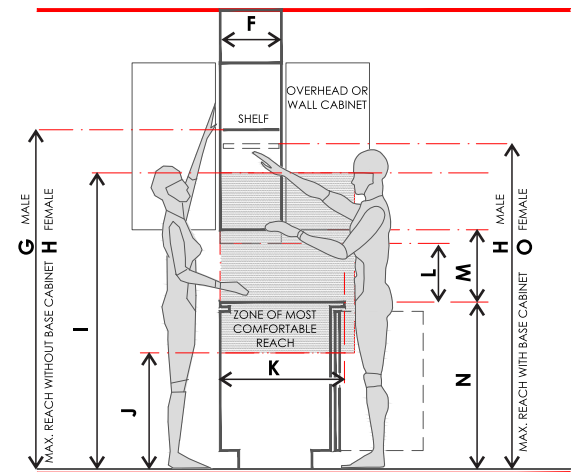

COUNTER AND BASE CABINETS / GENERAL CLEARANCE

CABINET REACH COMPARISON

Exhibit 14: **COUNTER AND CABINETS**

## Layout Considerations

- Wash hand basins are to be provided at convenient location.
- Adequate floor drainage gullies should be installed for floor cleaning.
- Sufficient equipment should be provided according to need/use.

## Equipment & Fittings- Vegetables and Meat Preparation Area

### Wash hand basins (Refer Exhibit 15)

- One wash hand basin within each food preparation area with foot or knee operated taps must be provided (ideal location - entry/exit).
- Wash hand basins/counters/tops should be positioned in such a way that the water droplets from hand washing, do not come in contact with surrounding work surfaces.
- Wash hand basins should not be included in worktops. They should be separated with a physical or air gap in between to minimize cross contamination.
- There should be hot water in all basins (at least 43°C)

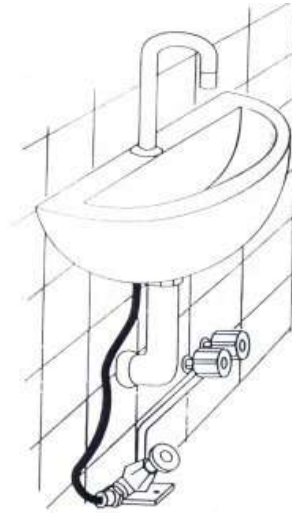
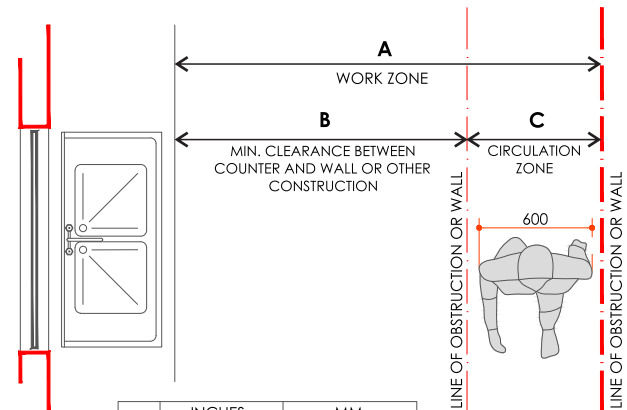
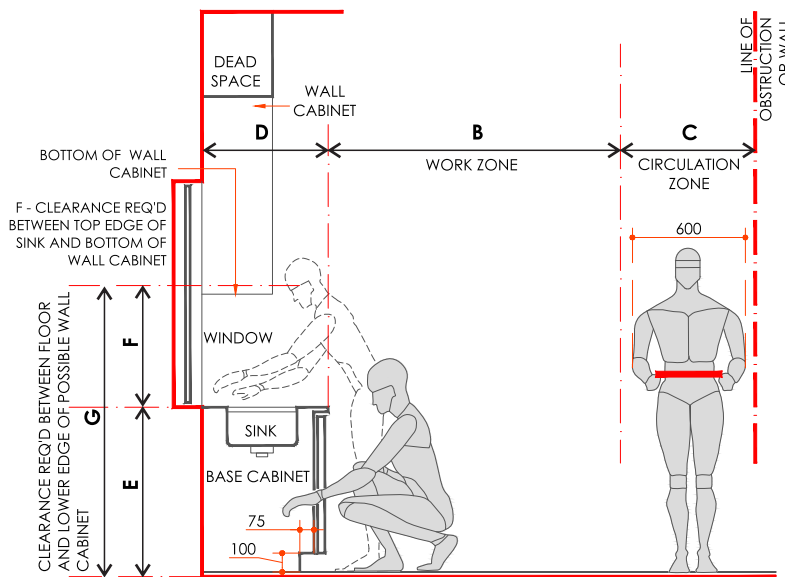

Exhibit 15: **FOOT OPERATED WASH HAND BASIN**



	INCHES	MM
A	70 - 76	1750 - 1900
B	40 MIN.	1000 MIN.
C	30 - 36	600 - 900
D	24 - 26	600 - 650
E	35 - 36	875 - 900
F	22 MIN.	550 MIN.
G	57 MIN.	1425 MIN.

Exhibit 16: **Work zone clearance**



### Sinks (Refer Exhibit 16, pg 17)

- Adequate space should be provided adjacent to sinks for holding, draining and drying.
- Sinks are required to have hot water for washing operations.
- Sinks should be provided to suit the largest piece of equipment being cleaned.
- All fixtures, furniture, equipment, tools and utensils should be of stainless steel or any other quality material that is anti rust, durable and easy to be cleaned.
- No wooden items are allowed inside the kitchen. Wooden furniture covered with stainless steel is not acceptable.
- Double bowl sink for vegetable and other ingredients' wash in each food preparation area.
- Food processor, blenders, vegetable peelers, cutter and slicers.
- Meat slicers and mincers.

## G. Cooking Area

Cooking area is the main hub of the facility. It has a functional relationship with storage and preparation areas, thaali filling and the pot wash.

### Layout Considerations

- Filtered/treated water should be available for use in cooking.
- Minimum 1800 mm clear distance shall be provided between two adjacent working surfaces. For example, in vegetable preparation area or meat preparation area **(Refer Exhibit 20, pg 21)**
- Minimum 2000 mm clear distance shall be provided between two adjacent work surfaces where the working process is considered to be dangerous. For example, cooking stoves and thaali filling table **(Refer Exhibit 20, pg 21)**
- Services like water supply, electricity, gas should be clubbed together into a service spine and then connected to the required equipments.



- The connections to equipment shall be minimum 300mm clear of the floor and minimum 150mm clear of the walls. **(Refer Exhibit 20, pg 21)**
- All equipment should be mobile to facilitate cleaning and maintenance.
- Stoves have to be in accordance to the amount and volume of work and thaali served.
- Recommendation of kitchen designers is as follows:
  - 200 persons: 4 stoves
  - 400 persons: 5 stoves
  - 800 persons: 8 stoves

## Equipment & Fittings

- Stoves and stove trolleys **(Refer Exhibit 17,18)**
- Deep fryers
- Utensils and pots
- Spices trolley **(Refer Exhibit 19)**

## H. Thaali Filling & Distribution

It requires a clear area, depending on size of operation.

## Layout Considerations

- The thaali distribution area should be located in a way that allows the collection of thalis without accessing the kitchen/thaali filling area.

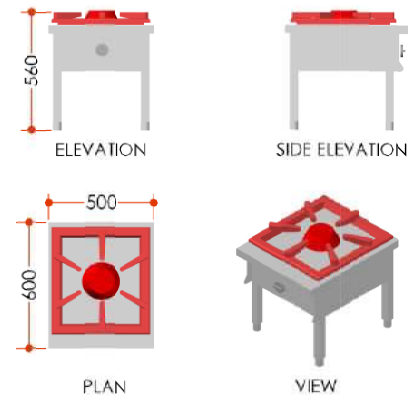

Exhibit 17: **FIXED STOVE**

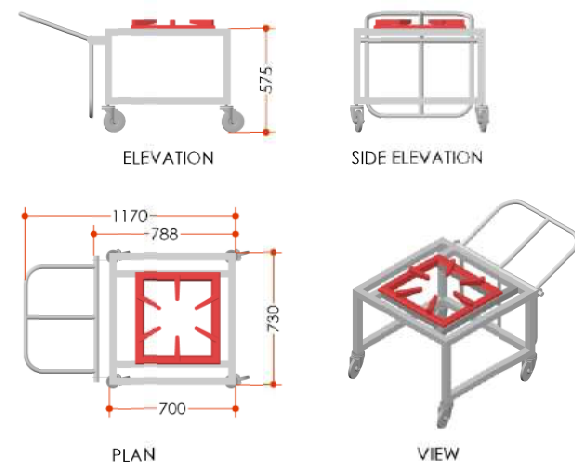

Exhibit 18: **STOVE TROLLEY THAT CAN BE WHEELED IN PLACE OVER BURNER (FOR 200 PAX SIZE DEGH)**



- Thaali filling area should be accessible from kitchen and sufficient circulation and holding space for staff, utensils with cooked food, empty tiffins and mobile furniture must be provided.
- Source of water and drainage for easy maintenance and cleaning of the area.
- Care should be taken by enclosing the area to prevent animals, pests and insects from entering.

## Equipment & Fittings

- Stainless-steel tables racks to stack the empty and filled thaali.

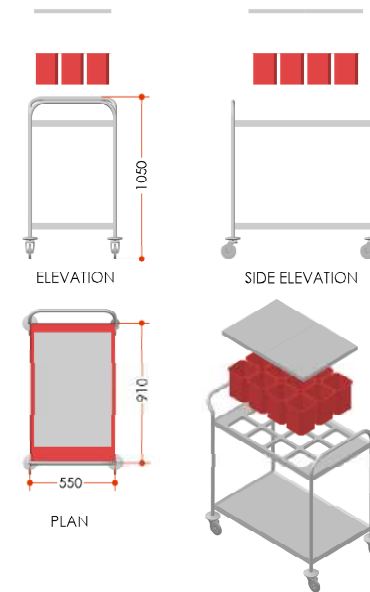

Exhibit 19: **SPICES TROLLEY**

## I. Zabihat & Butchery

Zabihat and butchery area should not interfere with any other areas of the kitchen.

### Layout Considerations

- It should have a secluded entrance.
- A curbed-in bleeding area of adequate size shall be provided to avoid splashing of blood in other areas. Provision should be made for soil or sand for zabihat.
- Walls of this area should be covered with ceramic tiles, vinyl or epoxy for ease of cleaning.
- Flooring should be laid to slope, non-absorbent, non-slippery, crack free and of lighter color (recommended materials - epoxy, MMA or kota stone with epoxy grouting).



- All permanently mounted equipment shall be installed above the floor (min 300 mm) to provide access for cleaning and inspection to the floor area.
- Water supply and drainage should be provided in bleeding and dressing areas for ease of cleaning.
- Adequate holding area can be provided for animals.

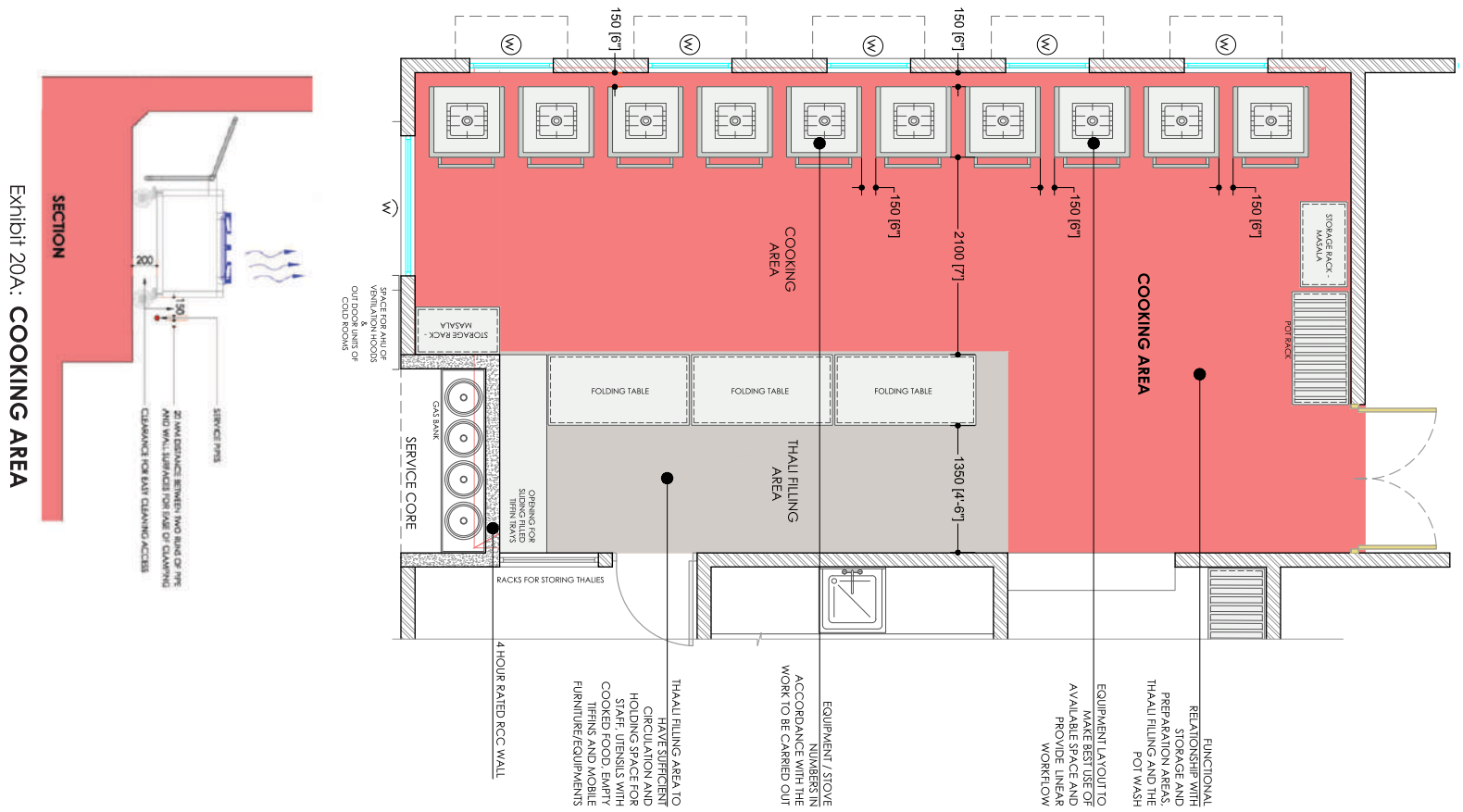

Exhibit 20B: COOKING AREA - KEY DESIGN FACTORS



## Equipment & Fittings

- Weighing scale
- Stainless steel tables and hooks
- Plastic chopping boards
- Sinks/hand-wash basin with hot and cold water
- Bone saw and meat grinding machine.

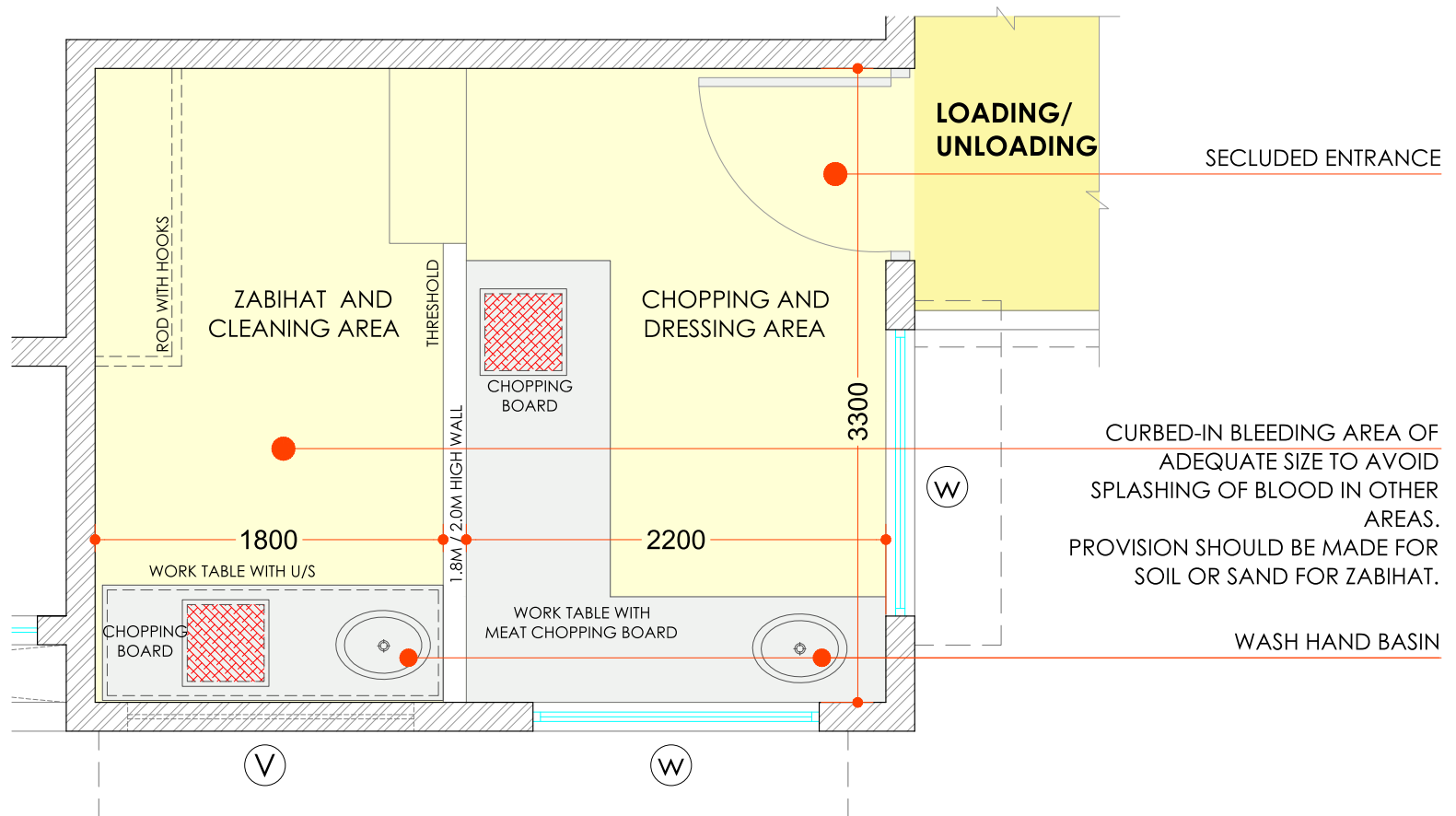

Exhibit 21: ZABIHAT ROOM

## J. Roti Making Area

The room has functional relationship with the stores and thaali filling areas.

### Layout Considerations

- It should be made separate from the main kitchen areas so that it does not interfere with the other kitchen activities.
- Roti making area should have enough area to make roti for all thaali.
- Sufficient natural or mechanical ventilation should be provided.
- Provision for both hot and cold water must be done.
- The area may have arrangements for making roti while sitting.

### Equipment & Fittings

- *Patla* , *velan* and *tawa*
- Stove
- Sinks
- Packing equipments
- Dough kneading machine

## K. Pot Wash

All cooking equipment from the preparation, cooking, roti making and thaali filling areas are washed here.

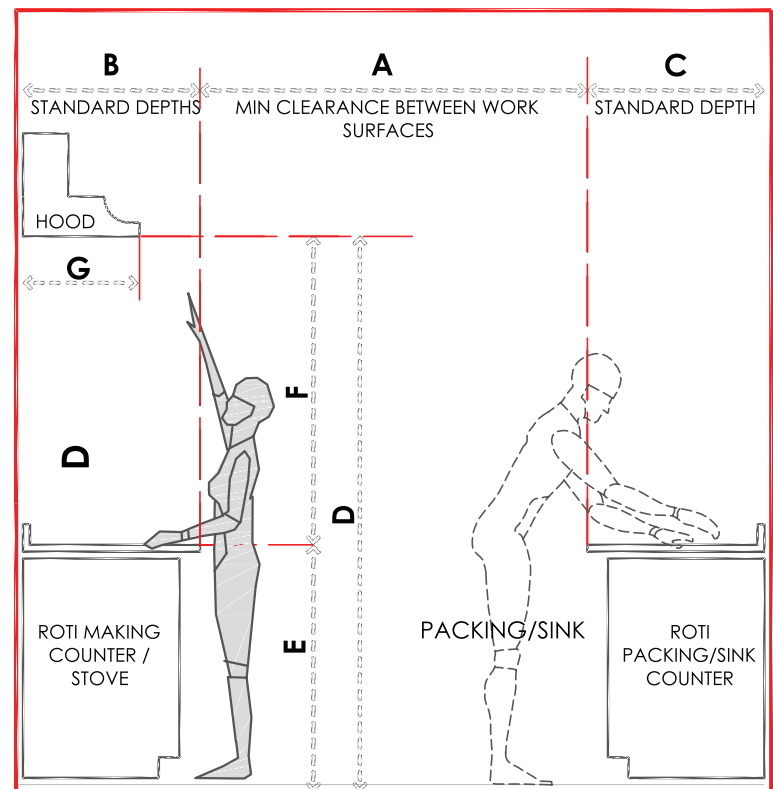

	INCHES	MM
A	48 MIN.	1200
B	24 - 27.5	600 - 700
C	24 - 26	600 - 650
D	78 MAX.	2000 MAX.
E	35 - 36.25	875 - 900
F	44 MAX.	1125 MAX.
G	18 MAX.	450 MAX.

Exhibit 22: **ROTI MAKING AREA**



## Layout Considerations

- The area should be sufficient for all utensils used on an average day, considering the biggest *degh* in the kitchen.
- The layout should allow adequate space to receive the dirty utensils and scraping and sorting of containers and pans and provide a linear flow.
- Provision for both hot and cold water must be done. High pressure shower/hoses for easy cleaning of grease can be provided.
- Adequate ventilation and extraction shall be provided to ensure that steam/hot air does not give rise to condensation within the room.
- It should have a beveled threshold that is 30cm high.
- Water proofing treatment must be done and should have adequate floor drains laid with slope to enable easy discharge of water and manual cleaning.
- A draining bench of sufficient size to allow adequate air drying prior to stacking can be provided.
- Sufficient storage space (stainless steel racks) for utensils pots and pans is to be provided for clean items.

## Equipment & Fittings

- Water hoses
- Wall-mounted liquid soap dispensers
- Stainless steel draining table or bench



## 6. SIGNAGE

The main purpose of signage is communication; to convey information such that its receiver can make decisions based on the information provided.

In general, signage can be classified into the following:

- **Information:** signs giving information about services and facilities, e.g., maps, directories, instructions for use, etc.
- **Direction:** signs leading to services, facilities, functional spaces and key areas, e.g., sign posts, directional arrows, etc.
- **Identification:** signs indicating services and facilities, e.g., room names & numbers, toilet signs, number of floors, etc.
- **Safety and Regulatory:** signs giving warning or safety instructions, e.g., warning signs, prohibitory signs, traffic signs, exit signs, rules & regulations, etc. (Refer Exhibit 23 & 24)



Exhibit 23: PROHIBITORY SIGNS



Exhibit 24: WARNING SIGNS



Food safety and kitchen signs are the easy way to make food preparation and kitchen safety messages clear to everyone. Signage must be provided for all areas, rooms, equipments and functions. i.e. kitchen rules, kitchen PPE, food preparation, housekeeping, dangers, hazards etc. The aim is to increase awareness about safety and hygiene by providing different signage like:

## Emergency & Exit Signs

- Exit signs with directional arrows, to direct people to exit doors in the case of an emergency must be clearly visible at all times. **(Refer Exhibit 25, pg 26)**



Exhibit 25: **FIRE EMERGENCY SIGNAGE**

## Fire Emergency Signage

- It is necessary to provide signage that shows what to do in the event of a fire **(Refer Exhibit 25, & Exhibit 27, pg 27)**
- The color for identifying fire equipment is red and escape routes is green.
- A fire safety sign:
  1. Provides information on escape routes and emergency exits in case of fire;
  2. Provides information on the identification or location of firefighting equipment;
  3. Gives warning in case of fire.



Exhibit 26: **FIRST AID SIGNAGES**



## First Aid Signage

- Signs should be installed to make staff aware of the location and use of first aid kits.
- A poster is displayed to explain the correct procedures of CPR (Cardiopulmonary Resuscitation). (Refer Exhibit 26, pg 26)

## Hygiene Signage

### i. Personal hygiene signage:

Personal hygiene of staff is important to prevent contamination of food (Refer Exhibit 28, pg 29) . Signs should be displayed in kitchens to make staff aware of:

- The correct procedures for washing hands, and when this must be done
- What do in the event of minor illness/accidents.
- Grooming, clothes, wearing of jewelry, tying of hair, wearing of disposable caps and gloves etc.

### ii. Kitchen hygiene Signage:

- Signs with the necessary procedures/steps to keep the kitchen clean and hygienic (Refer Exhibit 28, pg 29). These should include guidelines for all areas like food preparation, processing and storage etc.
- Signs showing type, location and route of waste bins must be installed.



Exhibit 27: FIRE FIGHTING SIGNAGES



### iii. Checklist:

- To keep track of hygiene and cleanliness issues, a checklist of procedures is recommended (**Refer Exhibit 28, pg 29**). The checklist should provide a brief description of what is required, with other relevant information such as the cleaning procedure, and the cleaning product used to achieve the best result.

### iv. Cleaning Chemicals Signage:

- A sign explaining the use and potential hazards of each product.
- It is advisable to use different color coded containers to store different chemicals for users ease.

### v. Equipment Signage:

- Signs to be installed adjacent to all equipment that explains their correct use including safety requirements, and procedures for cleaning.

## Minimum general requirements concerning signboards :

- Signboards should be of durable, shock and weather-resistant material.
- The dimensions, colors and designs of signboards must be such that they can be easily seen and understood.
- All signs need should be fixed securely and properly maintained.
- Installation:
  - in a well-lit, easily accessible and visible location
  - at a suitable height and in the clear line of sight



Exhibit 28: **MANDATORY SIGNS**

TABLE 01: SAFETY SIGN COLOURS		
COLOUR	MEANING OR PURPOSE	INSTRUCTION AND INFORMATION
RED	PROHIBITION SIGN DANGER ALARM	DANGEROUS BEHAVIOR; STOP; SHUT-DOWN; EMERGENCY CUT-OUT DEVICES, EVACUATE
YELLOW OR AMBER	WARNING SIGN	BE CAREFUL; TAKE PRECAUTIONS; EXAMINE
BLUE	MANDATORY SIGN	SPECIFIC BEHAVIOR OR ACTION, E.G. WEAR PROTECTIVE EQUIPMENT
GREEN	EMERGENCY ESCAPE FIRST-AID NO DANGER	SIGN DOORS; EXITS; ESCAPE ROUTES; EQUIPMENT AND FACILITIES RETURN TO NORMAL



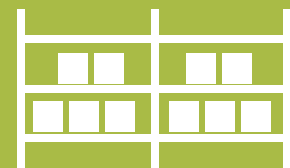
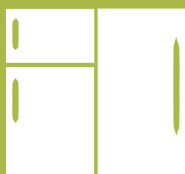

---

This booklet is **Part I** of three parts that constitute the FMB guidelines for a smart kitchen.  
For complete understanding please also refer to:

Part II

Part III